

LED Autolamps Boat Trailer Harness System

Functional, Long Lasting Quality, Value for Money

Innovated Harness System

The key to this system is its ease of fitting. Wiring of a trailer will be completed faster, which is perfect for trailer manufacturers, DIY, or non-skilled fitters, saving time and money. No cutting, no soldering, no taping, and a professional finish.

Flexibility

The system consists of individual cables for box trailers to large tandem trailers with cable lengths up to 8 metres and widths up to 2.1 metres. Boat trailer cable lengths available up to 12 metres. All cables have 2 core accessory plugs that enable licence and marker lamps to be added if required.

Cable and Plugs

The Cables and plugs are specially designed with tinned copper terminals and unique sealing plug rings. They also have waterproof grease added for extra protection, ensuring water resistant, submersible connections.

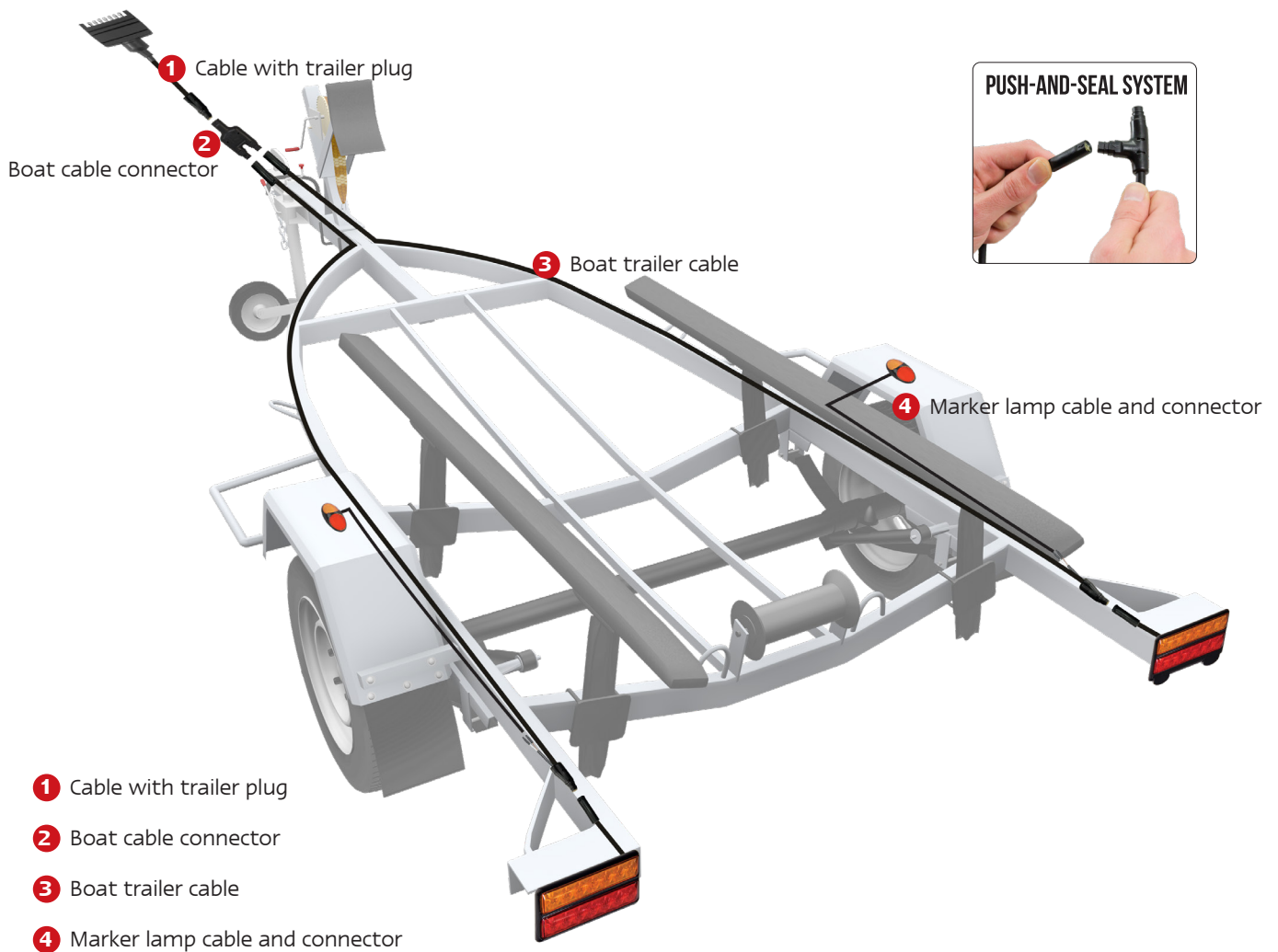

- **No Tools Required**
- **No Soldering**
- **No Cutting**
- **No Joiners**
- **No Splicing**
- **No Tape**

BOAT TRAILER

Plug in Harness System



Boat Trailer Cable - this cable connects each light to the gooseneck area and then plugs into the boat cable joiner. The male plug to the lamp has two accessory wires for side markers.



Part Numbers

BC400 - 4.0 metre	BC560 - 5.6 metre	BC700 - 7.0 metre	BC1000 - 1.0 metre
BC500 - 5.0 metre	BC600 - 6.0 metre	BC800 - 8.0 metre	





Boat Cable Connector - this three-way connector joins the left and right boat trailer cables to the cable with the trailer plug.







Part No. BCC1

Gooseneck to Vehicle with Trailer Plug - this 1-metre cable is fitted to the gooseneck. This cable ends with a trailer plug. You can also add the 5C1MB or the 5C1.5MB to extend the trailer plug length.

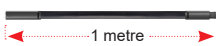

Part Numbers

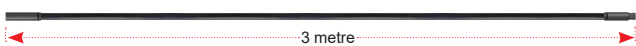
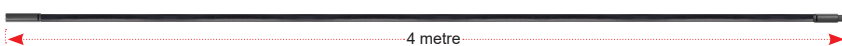
 5C81 - 7 Pin Round	 5C21 - 7 Pin Small Round	 5C41 - 7 Pin Flat
 5C1MB - 1 metre	 5C1.5MB - 1.5 metre	

Marker Lamp Cable and Plugs - For fitting marker lamps to the trailer harness system.

 Part No. 2PMF1B 1 metre	
 Part No. 2PMF2B 2 metre	See Marker Lamp Section Pages 18-45.
 Part No. 2PMF3B 3 metre	
 Part No. 2PMF4B 4 metre	
 Part No. 2PMF5B 5 metre	

2P to 2PMF Cable Adapters - These adapters allow for the older 2P plug system to be adapted into the 2C 2 core harness system. The 2PM2PF allows a 2 Pin Truck Harness male plug to adapt to the 2 Pin Small Harness female plug. The 2PF2PM allows a 2 Pin Truck Harness female plug to adapt to the 2 Pin Small Harness male plugs.

 Part No. 2PM2PF	 Part No. 2PF2PM
--	---

Cable System Kits for Boat Trailers, Easy Off the Shelf Reseller

	Part No. BTK8F 8m Cable Kit Flat Plug		Part No. BTK8UNI Universal 8m Cable Kit
			